

Multi-mode Passive Fiber Network TAP

1G/10G/25G/40G/100G | Portable



Network test access points (TAPs) are hardware tools that allow you to monitor your network. All fiber breakout TAPs are passive, purpose-built hardware devices that make a 100% copy of your network's data allowing your monitoring tools to see every bit, byte and packet.®

Passive TAPs are non-powered devices that will not cause the live network devices to lose link between one another if power is lost.

Key Features •

- 100% network visibility
- 100% secure and invisible; no IP address; no Mac address; cannot be hacked
- Passes physical layer errors
- TAPs constructed with durable, crush-resistant materials (metal)
- Supports Breakout Mode
- Supports Jumbo frames
- 1U rack mount kit holds up to 4 modules, each module can have 1, 2, 3 or 4 TAPs
- Plug & Play easy installation, no configuration; no power source required
- Made, tested and certified in the USA

Network Flow •

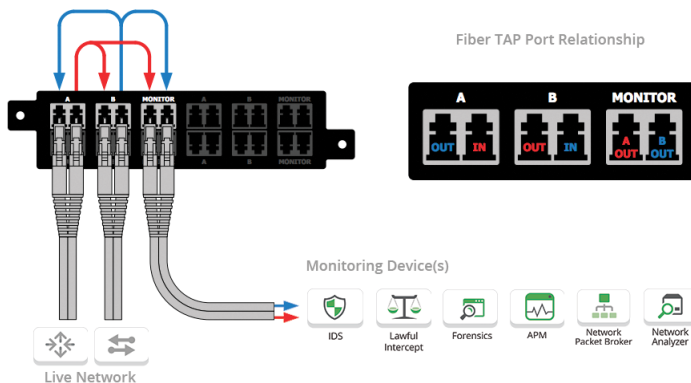

APPLICATIONS:

- Network & Application Monitoring
- Network & Application Analysis
- Network & Application Performance

+ Breakout Mode is ideal when utilization is very high and packet loss is not an option.

SOLUTIONS:

Passive optical TAPs are ideal for:

- IDS
Intrusion Detection Systems
- APM
Application Performance Monitoring
- Lawful Intercept
Lawful Interception
- Packet Capture
Packet Capture
- DPI
Deep Packet Inspection
- Network Analyzer
Network Analyzer
- Forensics
Forensics

Competitive Edge

- New Prism based technology that reduces bit errors on OM3 + OM4 applications, providing 100% utilization.
- Tested and Certified



































Have Questions?

sales@garlandtechnology.com
+716.242.8500
garlandtechnology.com

Multi-mode Passive Fiber Network TAP

1G/10G/25G/40G/100G | Portable

Model #	Network Speed	Ports	# of TAPs	Split Ratio*	Wavelengths	Media	Connector/Mode
RMP-1U			1U Rack Mount Kit - Hold up to 4 Modules, each Module can have 1, 2, 3 or 4 TAPs				
OM1501	10G		1	50/50	850/1300nm	Fiber-OM1	Fiber-LC Multi-Mode Fiber
OM1701	10G		1	70/30	850/1300nm	Fiber-OM1	Fiber-LC Multi-Mode Fiber
OM3501	10G		1	50/50	850/1300nm	Fiber-OM3	Fiber-LC Multi-Mode Fiber
OM4501	10G		1	50/50	850nm	Fiber-OM3/OM4	Fiber-LC Multi-Mode Fiber
OM4701	10G		1	70/30	850nm	Fiber-OM3/OM4	Fiber-LC Multi-Mode Fiber
OM4701-40GSR-BiDi	40G		1	70/30	800-950nm	Fiber-OM3/OM4	Fiber-LC Multi-Mode Fiber
OM5501	1/10/40/100G		1	50/50	850-950nm	Fiber OM5	Fiber-LC-Multi-Mode Fiber
OM5701	1/10/40/100G		1	70/30	850-950nm	Fiber OM5	Fiber-LC-Multi-Mode Fiber
OM1502	10G		2	50/50	850/1300nm	Fiber-OM1	Fiber-LC Multi-Mode Fiber
OM1702	10G		2	70/30	850/1300nm	Fiber-OM1	Fiber-LC Multi-Mode Fiber
OM3502	10G		2	50/50	850/1300nm	Fiber-OM3	Fiber-LC Multi-Mode Fiber
OM4502	10G		2	50/50	850nm	Fiber-OM3/OM4	Fiber-LC Multi-Mode Fiber
OM4702	10G		2	70/30	850nm	Fiber-OM3/OM4	Fiber-LC Multi-Mode Fiber
OM4702-40GSR-BiDi	40G		2	70/30	802-950nm	Fiber-OM3/OM4	Fiber-LC-Multi-Mode Fiber
OM5502	1/10/40/100G		2	50/50	850-950nm	Fiber OM5	Fiber-LC-Multi-Mode Fiber
OM5702	1/10/40/100G		2	70/30	850-950nm	Fiber OM5	Fiber-LC-Multi-Mode Fiber
OM1503	10G		3	50/50	850/1300nm	Fiber-OM1	Fiber-LC Multi-Mode Fiber
OM1703	10G		3	70/30	850/1300nm	Fiber-OM1	Fiber-LC Multi-Mode Fiber
OM3503	10G		3	50/50	850/1300nm	Fiber-OM3	Fiber-LC Multi-Mode Fiber
OM4503	10G		3	50/50	850nm	Fiber-OM3/OM4	Fiber-LC Multi-Mode Fiber
OM4703	10G		3	70/30	850nm	Fiber-OM3/OM4	Fiber-LC Multi-Mode Fiber
OM4703-40GSR-BiDi	40G						
OM5503	1/10/40/100G		3	50/50	850-950nm	Fiber OM5	Fiber-LC-Multi-Mode Fiber
OM5703	1/10/40/100G		3	70/30	850-950nm	Fiber OM5	Fiber-LC-Multi-Mode Fiber
OM1504	10G		4	50/50	850/1300nm	Fiber-OM1	Fiber-LC Multi-Mode Fiber
OM1704	10G		4	70/30	850/1300nm	Fiber-OM1	Fiber-LC Multi-Mode Fiber
OM3504	10G		4	50/50	850/1300nm	Fiber-OM3	Fiber-LC Multi-Mode Fiber
OM4504	10G		4	50/50	850nm	Fiber-OM3/OM4	Fiber-LC Multi-Mode Fiber
OM4704	10G		4	70/30	850nm	Fiber-OM3/OM4	Fiber-LC Multi-Mode Fiber
OM5504	1/10/40/100G		4	50/50	850-950nm	Fiber OM5	Fiber-LC-Multi-Mode Fiber
OM5704	1/10/40/100G		4	70/30	850-950nm	Fiber OM5	Fiber-LC-Multi-Mode Fiber

*Custom split ratios are available in 60/40, 80/20 or 90/10, please inquire.

Additional

Dimensions: (HxWxD): 1.72" x 3.9" x 6.8"
(43.69mm x 99.06mm x 172.72mm)

Weight: 1.45 lbs (0.66 kg)

Ambient Temperature: 0C to +40C / +32F to +104F

Storage Temperature: -20C to +70C / -4F to +158F

Humidity: 90% non-condensing

*There is no power needed for these TAPs

Multimode

Fiber Type: Corning 62.5/125 or 50/125 micron

Directivity: ≥40dB

Temperature: -40 to +85C

Packaging: Stainless steel tube, 3.05mm (dia) x 55mm (len)

Multi-mode Passive Fiber Network TAP

1G/10G/25G/40G/100G | Portable

Optical Fiber Insertion Loss for OM1, OM2, OM3 with 850/1300nm

Splitter: Multi-Mode with LC Connector*		
Split Ratio	Network Port	Monitor Port
50/50	3.7 dB	3.7 dB
70/30	2.1 dB	6.1 dB
Splitter plus loss with one mated pair**		
Split Ratio	Network Port	Monitor Port
50/50	4 dB	4 dB
70/30	2.4 dB	6.4 dB

Optical Fiber Insertion Loss for OM4 with 850nm

Splitter: Multi-Mode with LC Connector*		
Split Ratio	Network Port	Monitor Port
50/50	3.8 dB	3.8 dB
70/30	1.8 dB	6.6 dB
Splitter plus loss with one mated pair**		
Split Ratio	Network Port	Monitor Port
50/50	4.1 dB	4.1 dB
70/30	2.1 dB	6.9 dB

*Measured loss through splitter only **Measured loss through splitter; plus one mated pair (two fibers terminated and connected together with a fiber optic coupler). For methodology read: Tech Notes on [Measuring Budget Light Loss](#).



This document is for informational purposes only. The information in this document, believed by Garland Technology to be accurate as of the date of publication, is subject to change without notice. Garland Technology assumes no responsibility for any errors or omissions in this document and shall have no obligation to you as a result of having made this document available to you or based upon the information it contains. ©2019 Garland Technology LLC. All Rights Reserved