

# Single-mode Passive Fiber Network TAP

1G/10G/25G/40G/100G | Portable



Network test access points (TAPs) are hardware tools that allow you to monitor your network. All fiber breakout TAPs are passive, purpose-built hardware devices that make a 100% copy of your network's data allowing your monitoring tools to see every bit, byte and packet.®

Passive TAPs are non-powered devices that will not cause the live network devices to lose link between one another if power is lost.

## Key Features

- 100% network visibility
- 100% secure and invisible; no IP address; no Mac address; cannot be hacked
- Passes physical layer errors
- Supports Breakout Mode
- Supports Jumbo frames
- TAPs constructed with durable, crush-resistant materials (metal)
- 1U rack mount kit holds up to 4 modules, each module can have 1, 2, 3 or 4 TAPs
- Plug & Play easy installation, no configuration; no power source required
- Made, tested and certified in the USA

## Network Flow

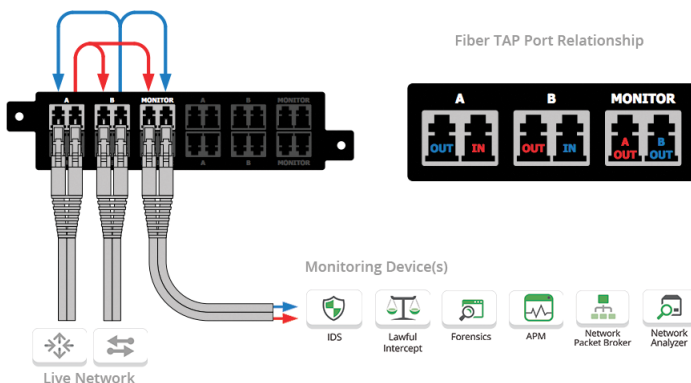

## APPLICATIONS:

- > Network & Application Monitoring
- > Network & Application Analysis
- > Network & Application Performance
- > Data Center-Longhaul fiber environment
- + Breakout Mode is ideal when utilization is very high and packet loss is not an option.

## SOLUTIONS:

Passive optical TAPs are ideal for:

- IDS: Intrusion Detection Systems
- APM: Application Performance Monitoring
- Lawful Intercept: Lawful Interception
- Packet Capture: Packet Capture
- DPI: Deep Packet Inspection
- Network Analyzer: Network Analyzer
- Forensics: Forensics

## Competitive Edge

- No upgrade needed. Unlike the competition, this handles your network today and tomorrow, and will work in all of your applications.
- Supports long range and extended range single-mode environments.
- Tested and Certified





















## Have Questions?

sales@garlandtechnology.com  
+716.242.8500  
garlandtechnology.com

# Single-mode Passive Fiber Network TAP

1G/10G/25G/40G/100G | Portable

| Model #     | Network Speed   | Ports   | # of TAPs  | Split Ratio* | Wavelengths                                 | Media     | Connector/Mode             |
|-------------|---|---|--|--------------|---|-----------|----------------------------|
| RMP-1U      |  |   | 1U Rack Mount Kit - Hold up to 4 Modules, each Module can have 1, 2, 3 or 4 TAPs |              |   |           |                            |
| OS1501      | Up to 100G  |    | 1  | 50/50        | 1310/1550nm                                 | Fiber-OS1 | Fiber-LC Single-Mode Fiber |
| OS1701      | Up to 100G  |    | 1  | 70/30        | 1310/1550nm                                 | Fiber-OS1 | Fiber-LC Single-Mode Fiber |
| OS2501      | Up to 100G  |    | 1  | 50/50        | 1310/1550nm                                 | Fiber-OS2 | Fiber-LC Single-Mode Fiber |
| OS2701      | Up to 100G  |    | 1  | 70/30        | 1310/1550nm                                 | Fiber-OS2 | Fiber-LC Single-Mode Fiber |
| OS1502      | Up to 100G  |    | 2  | 50/50        | 1310/1550nm                                 | Fiber-OS1 | Fiber-LC Single-Mode Fiber |
| OS1702      | Up to 100G  |    | 2  | 70/30        | 1310/1550nm                                 | Fiber-OS1 | Fiber-LC Single-Mode Fiber |
| OS2502      | Up to 100G  |    | 2  | 50/50        | 1310/1550nm                                 | Fiber-OS2 | Fiber-LC Single-Mode Fiber |
| OS2702      | Up to 100G  |    | 2  | 70/30        | 1310/1550nm                                 | Fiber-OS2 | Fiber-LC Single-Mode Fiber |
| OS2702-BiDi | 1/10  |    | 2  | 70/30        | 1270-1350nm/<br>1450-1530nm/<br>1510-1590nm | Fiber-OS2 | Fiber-LC Single-mode Fiber |
| OS1503      | Up to 100G  |    | 3  | 50/50        | 1310/1550nm                                 | Fiber-OS1 | Fiber-LC Single-Mode Fiber |
| OS1703      | Up to 100G  |    | 3  | 70/30        | 1310/1550nm                                 | Fiber-OS1 | Fiber-LC Single-Mode Fiber |
| OS2503      | Up to 100G  |    | 3  | 50/50        | 1310/1550nm                                 | Fiber-OS2 | Fiber-LC Single-Mode Fiber |
| OS2703      | Up to 100G  |   | 3  | 70/30        | 1310/1550nm                                 | Fiber-OS2 | Fiber-LC Single-Mode Fiber |
| OS1504      | Up to 100G  |  | 4  | 50/50        | 1310/1550nm                                 | Fiber-OS1 | Fiber-LC Single-Mode Fiber |
| OS1704      | Up to 100G  |  | 4  | 70/30        | 1310/1550nm                                 | Fiber-OS1 | Fiber-LC Single-Mode Fiber |
| OS2504      | Up to 100G  |  | 4  | 50/50        | 1310/1550nm                                 | Fiber-OS2 | Fiber-LC Single-Mode Fiber |
| OS2704      | Up to 100G  |  | 4  | 70/30        | 1310/1550nm                                 | Fiber-OS2 | Fiber-LC Single-Mode Fiber |

\*Custom split ratios are available in 60/40, 80/20 or 90/10, please inquire.

## Additional Specifications

### Optical Fiber Insertion Loss for OS1, OS2 with 1310/1550nm

| Splitter: Single-Mode (OS1, OS2) with LC Connector* |              |              |
|---|--------------|--------------|
| Split Ratio   | Network Port | Monitor Port |
| 50/50   | 3.6 dB       | 3.6 dB       |
| 70/30   | 1.9 dB       | 5.8 dB       |
| Splitter plus loss with one mated pair**            |              |              |
| Split Ratio   | Network Port | Monitor Port |
| 50/50   | 3.9 dB       | 3.9 dB       |
| 70/30   | 2.2 dB       | 6.1 dB       |

#### Single mode

Fiber Type: Corning 9/125 micron

Directivity: ≥50dB

Temperature: -40 to +85C

Packaging: Stainless steel tube, 3.05mm (dia) x 55mm (len)

#### Additional

Dimensions: (HxWxD): 1.72" x 3.9" x 6.8" (43.69mm x 99.06mm x 172.72mm)

Weight: 1.45 lbs (0.66 kg)

Ambient Temperature: 0C to +40C / +32F to +104F

Storage Temperature: -20C to +70C / -4F to +158F

Humidity: 90% non-condensing

\*There is no power needed for these TAPs

\* Measured loss through splitter only \*\* Measured loss through splitter; plus one mated pair (two fibers terminated and connected together with a fiber optic coupler).

For methodology read: Tech Notes on [Measuring Budget Light Loss](#).



This document is for informational purposes only. The information in this document, believed by Garland Technology to be accurate as of the date of publication, is subject to change without notice. Garland Technology assumes no responsibility for any errors or omissions in this document and shall have no obligation to you as a result of having made this document available to you or based upon the information it contains. ©2019 Garland Technology LLC. All Rights Reserved